

# TL331, TL331V

## Comparator, Single Channel, Open Collector, Low Power, Wide Supply Range

### Description

The TL331 is an open collector, low-power comparator designed specifically to operate over a wide supply range from 2 V to 36 V single supply and  $\pm 1$  V to  $\pm 18$  V for split supplies. The input common-mode voltage range includes ground, even when operated from a single power supply voltage. TL331 comes in a space saving TSOP-5 package and is also available in an automotive qualified version.

### Features

- Wide Single Supply Voltage Range or Dual Supplies
- Low Supply Current: 0.5 mA Typical
- Low Input Bias Current: 25 nA Typical
- Low Input Offset Current:  $\pm 5$  nA Typical
- Low Input Offset Voltage:  $\pm 2$  mV Typical
- Input Common Mode Voltage Range includes Ground
- Low Output Saturation Voltage: 150 mV Typ at  $I_O = 4$  mA
- Differential Input Voltage Range Equal to the Supply Voltage
- TTL, DTL, ECL, CMOS Compatible Devices
- TL331V for Automotive and Other Applications Requiring Unique Site and Control Change Requirements; AEC-Q100 Qualified and PPAP Capable\*
- These Devices are Pb-Free, Halogen Free/BFR Free and are RoHS Compliant

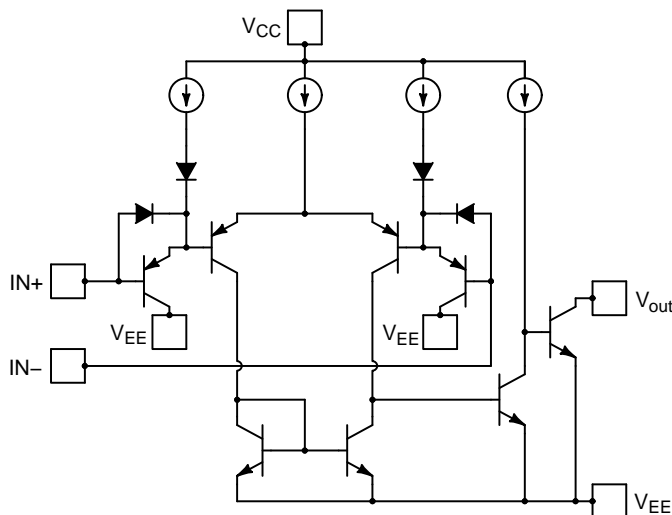

ON Semiconductor®

[www.onsemi.com](http://www.onsemi.com)

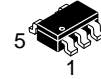

TSOP-5  
SN SUFFIX  
CASE 483

### MARKING DIAGRAM

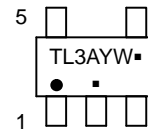

TL3 = Specific Device Code  
A = Assembly Location  
Y = Year  
W = Work Week  
▪ = Pb-Free Package

(Note: Microdot may be in either location)

### PIN CONNECTIONS

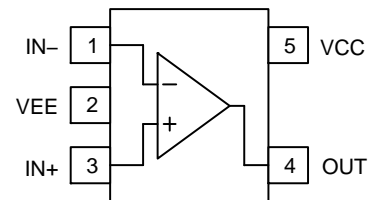

### ORDERING INFORMATION

Device	Package	Shipping†
TL331SN4T3G	TSOP-5 (Pb-Free)	3000 / Tape & Reel
TL331VSN4T3G*	TSOP-5 (Pb-Free)	3000 / Tape & Reel

†For information on tape and reel specifications, including part orientation and tape sizes, please refer to our Tape and Reel Packaging Specification Brochure, BRD8011/D.

# TL331, TL331V

**Table 1. MAXIMUM RATINGS** (Over operating free-air temperature, unless otherwise stated)

Parameter	Symbol	Limit	Unit
Supply Voltage ( $V_{CC} - V_{EE}$ )	$V_S$	36	V

### INPUT AND OUTPUT PINS

Input Voltage (Note 1)	$V_{IN}$	$\pm 36$	V
Differential Input Voltage (Note 1)	$V_{ID}$	-0.3 to 36	V
Output Short Circuit Current (Note 2)	$I_{SC}$	20	mA

### TEMPERATURE

Storage Temperature	$T_{STG}$	-65 to +150	°C
Junction Temperature	$T_J$	+150	°C

### ESD RATINGS

Human Body Model	HBM	2000	V
Charged Device Model	CDM	2500	V
Machine Model	MM	150	V

Stresses exceeding those listed in the Maximum Ratings table may damage the device. If any of these limits are exceeded, device functionality should not be assumed, damage may occur and reliability may be affected.

- Positive excursions of the input voltage may exceed the power supply level. The low input voltage state must not be less than 0.3 V below the negative supply rail.
- Short circuits from the output to  $V_{CC}$  can cause excessive heating and potential destruction. The maximum short circuit current is independent of the magnitude of  $V_{CC}$ .

**Table 2. THERMAL INFORMATION** (Note 3)

Parameter	Symbol	Single Layer Board (Note 4)	Multi-Layer Board (Note 5)	Unit
Junction to Ambient Thermal Resistance	$\theta_{JA}$	274	209	°C/W

- Short-circuits can cause excessive heating and destructive dissipation. These values are typical.
- Values based on a 1S standard PCB according to JEDEC 51-3 with 1.0 oz copper and a 400 mm<sup>2</sup> copper area
- Values based on a 1S2P standard PCB according to JEDEC 51-7 with 1.0 oz copper and a 25 mm<sup>2</sup> copper area

**Table 3. OPERATING CONDITIONS**

Parameter	Symbol	Limit	Unit
Operating Supply Voltage	$V_S$	2 to 36	V
Specified Operating Range	$T_A$	-40 to +125	°C

Functional operation above the stresses listed in the Recommended Operating Ranges is not implied. Extended exposure to stresses beyond the Recommended Operating Ranges limits may affect device reliability.

# TL331, TL331V

**Table 4. ELECTRICAL CHARACTERISTICS (Vs=+5.0 V, At TA = +25°C, VCM = mid-supply, unless otherwise noted)**  
**Boldface** limits apply over the specified temperature range, TA = -40°C to +125°C.

Parameter	Symbol	Test Conditions	Min	Typ	Max	Unit
-----------	--------	-----------------	-----	-----	-----	------

## INPUT CHARACTERISTICS

Input Offset Voltage	V <sub>OS</sub>	V <sub>O</sub> = 1.4 V, R <sub>S</sub> = 0 Ω, V <sub>S</sub> = 5 V to 30 V	V <sub>CM</sub> = 0 to V <sub>CC</sub> - 1.5 V	1	5	mV
			V <sub>CM</sub> = 0 to V <sub>CC</sub> - 2 V			<b>9</b>
Input Bias Current	I <sub>IB</sub>			-25	-250	nA
						<b>-400</b>
Input Offset Current	I <sub>OS</sub>			5	50	nA
						<b>150</b>
Input Common Mode Range (Note 6)	V <sub>ICMR</sub>		0		V <sub>CC</sub> - 1.5	V
Differential Input Voltage (Note 7)	V <sub>ID</sub>				V <sub>CC</sub>	V

## OUTPUT CHARACTERISTICS

Output Voltage Low	V <sub>OL</sub>	V <sub>ID</sub> = -1 V, I <sub>O</sub> = 4 mA		150	400	mV
						<b>700</b>
Output Sink Current	I <sub>O</sub>	V <sub>ID</sub> = -1 V, V <sub>O</sub> = 1.5 V	6	16		mA
Output Leakage Current	I <sub>OH</sub>	V <sub>ID</sub> = 1 V, V <sub>CC</sub> = V <sub>O</sub> = 5 V		0.1	50	nA
		V <sub>ID</sub> = 1 V, V <sub>CC</sub> = V <sub>O</sub> = 30 V			<b>1</b>	<b>μA</b>

## DYNAMIC PERFORMANCE

Large Signal Differential Voltage Gain	A <sub>VD</sub>	V <sub>CC</sub> = 15 V, R <sub>PJ</sub> = 15 kΩ, V <sub>O</sub> = 1.4 V to 11.4 V	50	200		V/mV
Propagation Delay L-H (Note 8)	t <sub>PLH</sub>	5 mV overdrive, R <sub>PJ</sub> = 5.1 kΩ		850		ns
		20 mV overdrive, R <sub>PJ</sub> = 5.1 kΩ		600		ns
		100 mV overdrive, R <sub>PJ</sub> = 5.1 kΩ		400		ns
		TTL Input, V <sub>ref</sub> = +1.4 V, R <sub>PJ</sub> = 5.1 kΩ		300		ns
Propagation Delay H-L	t <sub>PHL</sub>	5 mV overdrive, R <sub>PJ</sub> = 5.1 kΩ		700		ns
		20 mV overdrive, R <sub>PJ</sub> = 5.1 kΩ		400		ns
		100 mV overdrive, R <sub>PJ</sub> = 5.1 kΩ		250		ns
		TTL Input, V <sub>ref</sub> = +1.4 V, R <sub>PJ</sub> = 5.1 kΩ		300		ns

## POWER SUPPLY

Quiescent Current	I <sub>CC</sub>	No load, V <sub>CC</sub> = 5 V		0.5	0.7	mA
		No load, V <sub>CC</sub> = 30 V		0.6	1.25	mA

Product parametric performance is indicated in the Electrical Characteristics for the listed test conditions, unless otherwise noted. Product performance may not be indicated by the Electrical Characteristics if operated under different conditions.

- The input common mode voltage of either input signal should not be allowed to go negative by more than 0.3 V. The upper end of the common mode voltage range is V<sub>CC</sub> - 1.5 V, but either or both inputs can go to +36 V without damage.
- Positive excursions of the input voltage may exceed the power supply level. As long as the other voltage remains within the common mode range, the comparator will provide a proper output stage. The low input voltage state must not be less than 0.3 V below the negative supply rail.
- TL331 is an open collector comparator. Rise time is a function of the RC time constant. A 5.1 kΩ pull-up resistor was used for these measurements.

TYPICAL CHARACTERISTICS

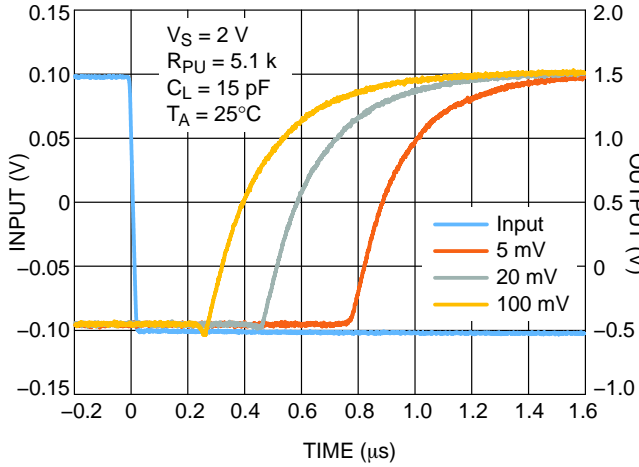

Figure 1. Low-to-High Propagation Delay vs. Overdrive at 2 V Supply

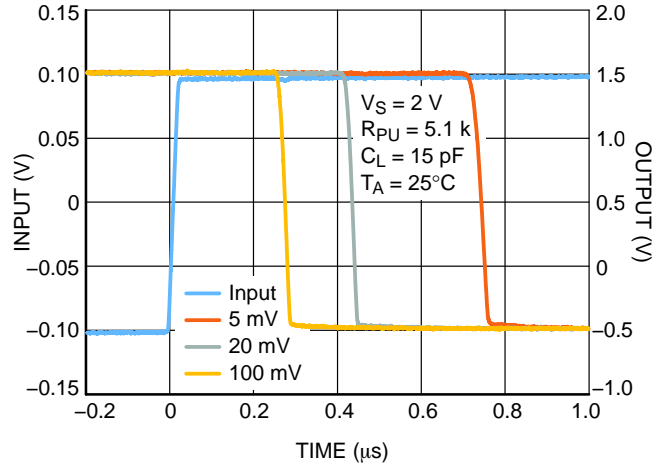

Figure 2. High-to-Low Propagation Delay vs. Overdrive at 2 V Supply

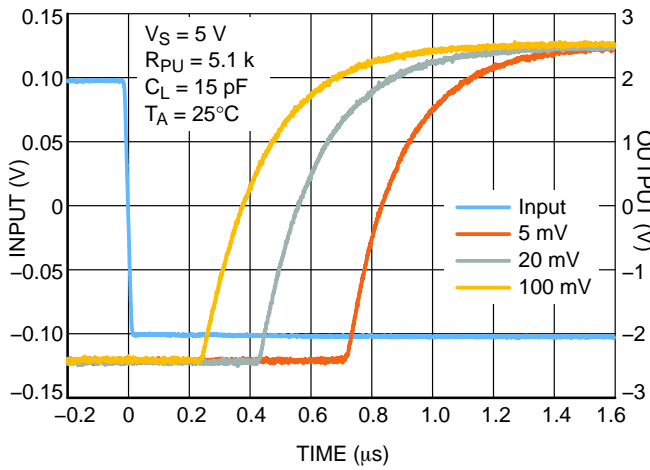

Figure 3. Low-to-High Propagation Delay vs. Overdrive at 5 V Supply

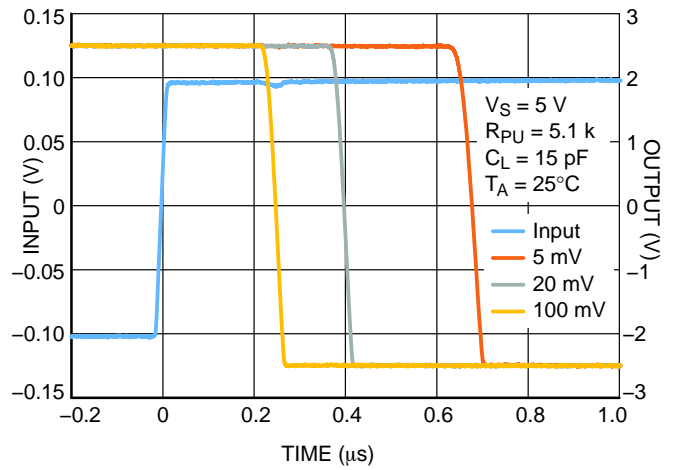

Figure 4. High-to-Low Propagation Delay vs. Overdrive at 5 V Supply

TYPICAL CHARACTERISTICS

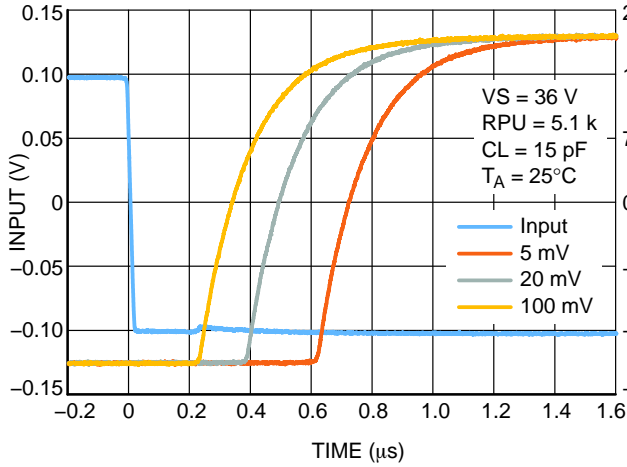

Figure 5. Low-to-High Propagation Delay vs. Overdrive at 36 V Supply

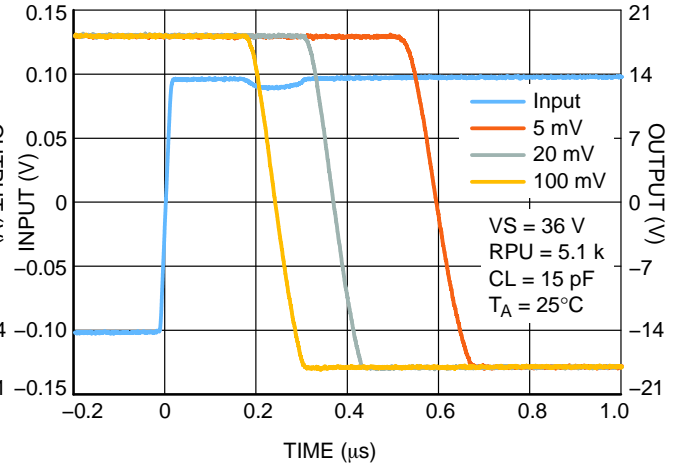

Figure 6. High-to-Low Propagation Delay vs. Overdrive at 36 V Supply

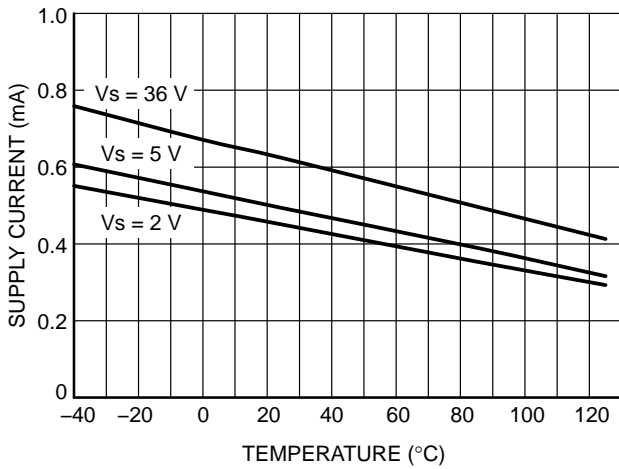

Figure 7. Quiescent Current vs. Temperature

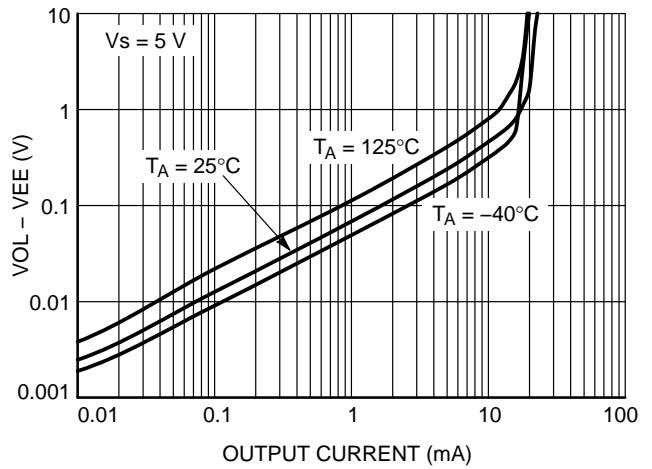

Figure 8. Low Level Output Voltage vs. Output Current at 5 V Supply

# MECHANICAL CASE OUTLINE PACKAGE DIMENSIONS

ON Semiconductor®



SCALE 2:1

## TSOP-5 CASE 483 ISSUE N

DATE 12 AUG 2020



NOTES:

1. DIMENSIONING AND TOLERANCING PER ASME Y14.5M, 1994.
2. CONTROLLING DIMENSION: MILLIMETERS.
3. MAXIMUM LEAD THICKNESS INCLUDES LEAD FINISH THICKNESS. MINIMUM LEAD THICKNESS IS THE MINIMUM THICKNESS OF BASE MATERIAL.
4. DIMENSIONS A AND B DO NOT INCLUDE MOLD FLASH, PROTRUSIONS, OR GATE BURRS. MOLD FLASH, PROTRUSIONS, OR GATE BURRS SHALL NOT EXCEED 0.15 PER SIDE. DIMENSION A.
5. OPTIONAL CONSTRUCTION: AN ADDITIONAL TRIMMED LEAD IS ALLOWED IN THIS LOCATION. TRIMMED LEAD NOT TO EXTEND MORE THAN 0.2 FROM BODY.

DIM	MILLIMETERS	
	MIN	MAX
A	2.85	3.15
B	1.35	1.65
C	0.90	1.10
D	0.25	0.50
G	0.95 BSC	
H	0.01	0.10
J	0.10	0.26
K	0.20	0.60
M	0°	10°
S	2.50	3.00

### SOLDERING FOOTPRINT\*



\*For additional information on our Pb-Free strategy and soldering details, please download the ON Semiconductor Soldering and Mounting Techniques Reference Manual, SOLDERRM/D.

### GENERIC MARKING DIAGRAM\*



- |                            |                            |
|----------------------------|----------------------------|
| XXX = Specific Device Code | XXX = Specific Device Code |
| A = Assembly Location      | M = Date Code              |
| Y = Year                   | ▪ = Pb-Free Package        |
| W = Work Week              |                            |
| ▪ = Pb-Free Package        |                            |

(Note: Microdot may be in either location)

\*This information is generic. Please refer to device data sheet for actual part marking. Pb-Free indicator, "G" or microdot "▪", may or may not be present.

<b>DOCUMENT NUMBER:</b>	<b>98ARB18753C</b>	Electronic versions are uncontrolled except when accessed directly from the Document Repository. Printed versions are uncontrolled except when stamped "CONTROLLED COPY" in red.
<b>DESCRIPTION:</b>	<b>TSOP-5</b>	<b>PAGE 1 OF 1</b>

ON Semiconductor and ON are trademarks of Semiconductor Components Industries, LLC dba ON Semiconductor or its subsidiaries in the United States and/or other countries. ON Semiconductor reserves the right to make changes without further notice to any products herein. ON Semiconductor makes no warranty, representation or guarantee regarding the suitability of its products for any particular purpose, nor does ON Semiconductor assume any liability arising out of the application or use of any product or circuit, and specifically disclaims any and all liability, including without limitation special, consequential or incidental damages. ON Semiconductor does not convey any license under its patent rights nor the rights of others.

ON Semiconductor and  are trademarks of Semiconductor Components Industries, LLC dba ON Semiconductor or its subsidiaries in the United States and/or other countries. ON Semiconductor owns the rights to a number of patents, trademarks, copyrights, trade secrets, and other intellectual property. A listing of ON Semiconductor's product/patent coverage may be accessed at [www.onsemi.com/site/pdf/Patent-Marking.pdf](http://www.onsemi.com/site/pdf/Patent-Marking.pdf). ON Semiconductor reserves the right to make changes without further notice to any products herein. ON Semiconductor makes no warranty, representation or guarantee regarding the suitability of its products for any particular purpose, nor does ON Semiconductor assume any liability arising out of the application or use of any product or circuit, and specifically disclaims any and all liability, including without limitation special, consequential or incidental damages. Buyer is responsible for its products and applications using ON Semiconductor products, including compliance with all laws, regulations and safety requirements or standards, regardless of any support or applications information provided by ON Semiconductor. "Typical" parameters which may be provided in ON Semiconductor data sheets and/or specifications can and do vary in different applications and actual performance may vary over time. All operating parameters, including "Typicals" must be validated for each customer application by customer's technical experts. ON Semiconductor does not convey any license under its patent rights nor the rights of others. ON Semiconductor products are not designed, intended, or authorized for use as a critical component in life support systems or any FDA Class 3 medical devices or medical devices with a same or similar classification in a foreign jurisdiction or any devices intended for implantation in the human body. Should Buyer purchase or use ON Semiconductor products for any such unintended or unauthorized application, Buyer shall indemnify and hold ON Semiconductor and its officers, employees, subsidiaries, affiliates, and distributors harmless against all claims, costs, damages, and expenses, and reasonable attorney fees arising out of, directly or indirectly, any claim of personal injury or death associated with such unintended or unauthorized use, even if such claim alleges that ON Semiconductor was negligent regarding the design or manufacture of the part. ON Semiconductor is an Equal Opportunity/Affirmative Action Employer. This literature is subject to all applicable copyright laws and is not for resale in any manner.

## PUBLICATION ORDERING INFORMATION

### LITERATURE FULFILLMENT:

Email Requests to: [orderlit@onsemi.com](mailto:orderlit@onsemi.com)

ON Semiconductor Website: [www.onsemi.com](http://www.onsemi.com)

### TECHNICAL SUPPORT

North American Technical Support:  
Voice Mail: 1 800-282-9855 Toll Free USA/Canada  
Phone: 011 421 33 790 2910

Europe, Middle East and Africa Technical Support:

Phone: 00421 33 790 2910

For additional information, please contact your local Sales Representative