

## P-channel 30 V, 0.048 $\Omega$ typ., 4 A STripFET™ H6 DeepGATE™ Power MOSFET in PowerFLAT™ 2x2 package

Datasheet - preliminary data

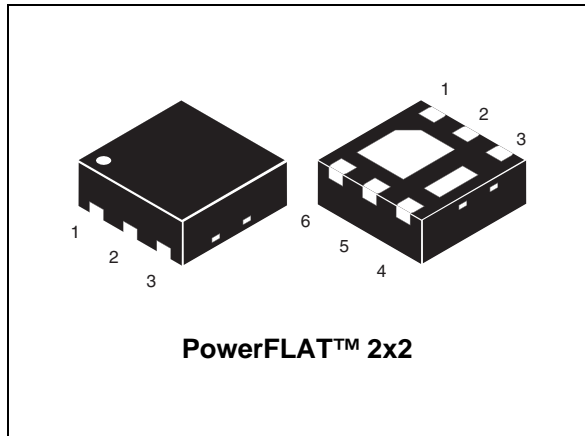
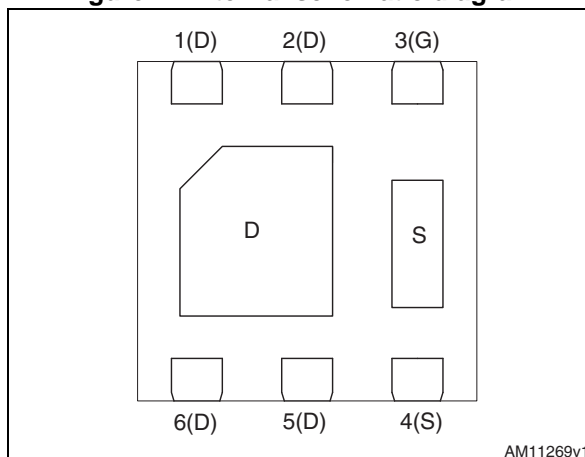

Figure 1. Internal schematic diagram



### Features

Order code	V <sub>DSS</sub>	R <sub>DS(on)</sub> max.	I <sub>D</sub>
STL4P3LLH6	30 V	0.056 $\Omega$ at 10 V	4 A

- Very low on-resistance R<sub>DS(on)</sub>
- Very low gate charge
- High avalanche ruggedness
- Low gate drive power loss

### Applications

- Switching application

### Description

This device is a P-channel Power MOSFET developed using the STripFET™ H6 technology with a new trench gate structure. The resulting Power MOSFET exhibits very low R<sub>DS(on)</sub> in all packages.

Table 1. Device summary

Order code	Marking	Package	Packaging
STL4P3LLH6	4K3L	PowerFLAT™ 2x2	Tape and reel

Note: For the P-channel MOSFET the actual polarity of the voltages and the current must be reversed.

## Contents

<b>1</b>	<b>Electrical ratings</b> .....	<b>3</b>
<b>2</b>	<b>Electrical characteristics</b> .....	<b>4</b>
	2.1 Electrical characteristics (curves) .....	6
<b>3</b>	<b>Test circuits</b> .....	<b>8</b>
<b>4</b>	<b>Package mechanical data</b> .....	<b>9</b>
<b>5</b>	<b>Revision history</b> .....	<b>12</b>

# 1 Electrical ratings

**Table 2. Absolute maximum ratings**

Symbol	Parameter	Value	Unit
$V_{DS}$	Drain-source voltage	30	V
$V_{GS}$	Gate-source voltage	$\pm 20$	V
$I_D$	Drain current (continuous) at $T_{amb} = 25\text{ }^\circ\text{C}$	4	A
$I_D$	Drain current (continuous) at $T_{amb} = 100\text{ }^\circ\text{C}$	2.75	A
$I_{DM}^{(1)}$	Drain current (pulsed)	16	A
$P_{TOT}$	Total dissipation at $T_{amb} = 25\text{ }^\circ\text{C}$	2.4	W
$T_J$	Operating junction temperature	150	$^\circ\text{C}$
$T_{stg}$	Storage temperature	-55 to 150	$^\circ\text{C}$

1. Pulse width limited by safe operating area

**Table 3. Thermal resistance**

Symbol	Parameter	Value	Unit
$R_{thj-amb}^{(1)}$	Thermal resistance junction-amb	52	$^\circ\text{C}/\text{W}$

1. When mounted on FR-4 board of 1inch<sup>2</sup>, 2oz Cu,  $t < 10$  sec

*Note:* For the P-channel MOSFET the actual polarity of the voltages and the current must be reversed.

## 2 Electrical characteristics

( $T_{CASE} = 25\text{ °C}$  unless otherwise specified).

**Table 4. On/off states**

Symbol	Parameter	Test conditions	Min	Typ	Max	Unit
$V_{(BR)DSS}$	Drain-source breakdown voltage	$V_{GS} = 0\text{ V}$ , $I_D = 250\text{ }\mu\text{A}$	30			V
$I_{DSS}$	Zero gate voltage drain current	$V_{GS} = 0\text{ V}$ , $V_{DS} = 30\text{ V}$			1	$\mu\text{A}$
		$V_{GS} = 0\text{ V}$ , $V_{DS} = 30\text{ V}$ , $T_J = 125\text{ °C}$			10	
$I_{GSS}$	Gate body leakage current	$V_{DS} = 0\text{ V}$ , $V_{GS} = \pm 20\text{ V}$			100	nA
$V_{GS(th)}$	Gate threshold voltage	$V_{DS} = V_{GS}$ , $I_D = 250\text{ }\mu\text{A}$	1		2.5	V
$R_{DS(on)}$	Static drain-source on-resistance	$V_{GS} = 10\text{ V}$ , $I_D = 2\text{ A}$		0.048	0.056	$\Omega$
		$V_{GS} = 4.5\text{ V}$ , $I_D = 2\text{ A}$		0.075	0.09	

**Table 5. Dynamic**

Symbol	Parameter	Test conditions	Min	Typ	Max	Unit
$C_{iss}$	Input capacitance	$V_{DS} = 25\text{ V}$ , $f = 1\text{ MHz}$ , $V_{GS} = 0\text{ V}$	-	639	-	$\mu\text{F}$
$C_{oss}$	Output capacitance		-	79	-	
$C_{rss}$	Reverse transfer capacitance		-	52	-	
$Q_g$	Total gate charge	$V_{DD} = 15\text{ V}$ , $I_D = 4\text{ A}$ , $V_{GS} = 4.5\text{ V}$	-	6	-	nC
$Q_{gs}$	Gate-source charge		-	1.9	-	
$Q_{gd}$	Gate-drain charge		-	2.1	-	

**Table 6. Switching times**

Symbol	Parameter	Test conditions	Min	Typ	Max	Unit
$t_{d(on)}$	Turn-on delay time	$V_{DD} = 15\text{ V}$ , $I_D = 4\text{ A}$ , $R_G = 4.7\text{ }\Omega$ , $V_{GS} = 10\text{ V}$	-	5.4	-	ns
$t_r$	Rise time		-	5	-	
$t_{d(off)}$	Turn-off delay time		-	19.2	-	
$t_f$	Fall time		-	3.4	-	

Table 7. Source drain diode

Symbol	Parameter	Test conditions	Min	Typ	Max	Unit
$V_{SD}^{(1)}$	Forward on voltage	$I_{SD} = 4 \text{ A}$ , $V_{GS} = 0$	-	-	1.1	V
$t_{rr}$	Reverse recovery time	$I_{SD} = 4 \text{ A}$ , $di/dt = 100 \text{ A}/\mu\text{s}$ , $V_{DD} = 16 \text{ V}$ , $T_J = 150 \text{ }^\circ\text{C}$	-	11.2	-	ns
$Q_{rr}$	Reverse recovery charge		-	3.5	-	nC
$I_{RRM}$	Reverse recovery current		-	0.6	-	A

1. Pulsed: pulse duration=300 $\mu\text{s}$ , duty cycle 1.5%

*Note:* For the P-channel MOSFET the actual polarity of the voltages and the current must be reversed.

## 2.1 Electrical characteristics (curves)

Figure 2. Safe operating area

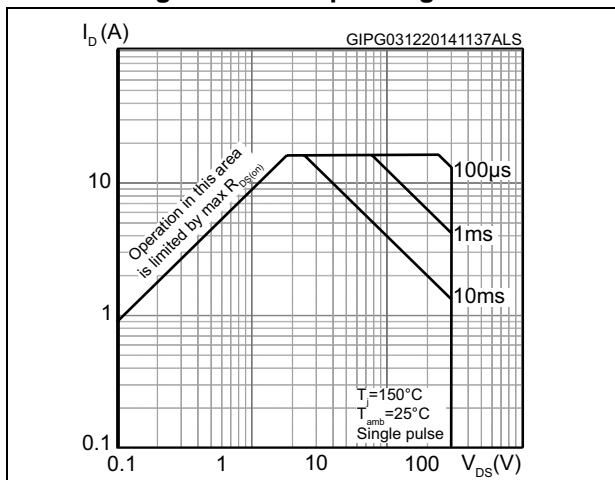

Figure 3. Thermal impedance

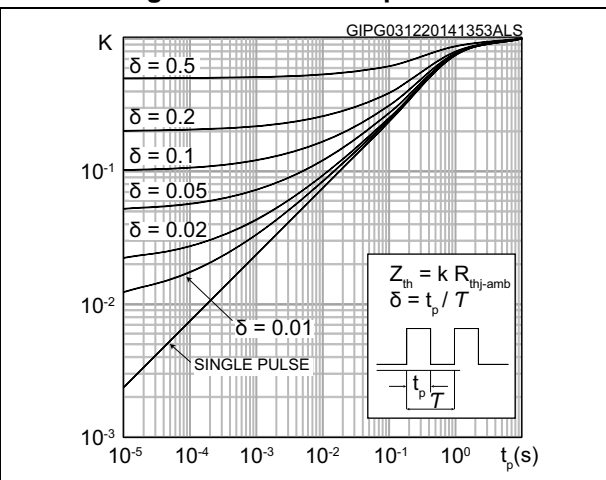

Figure 4. Output characteristics

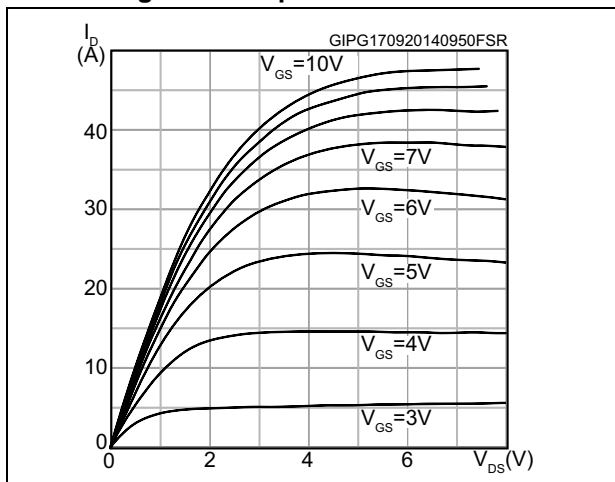

Figure 5. Transfer characteristics

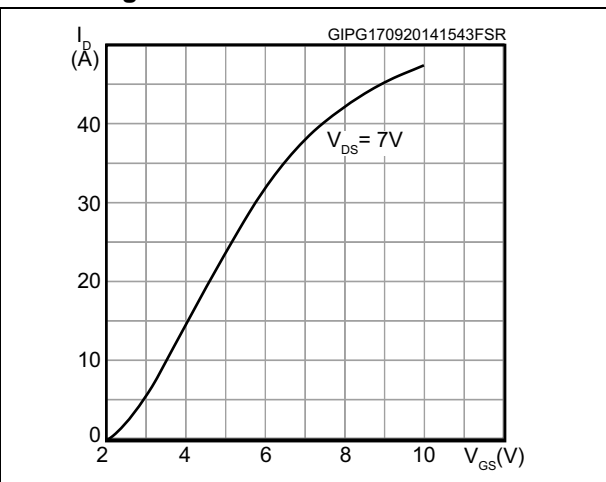

Figure 6. Gate charge vs gate-source voltage

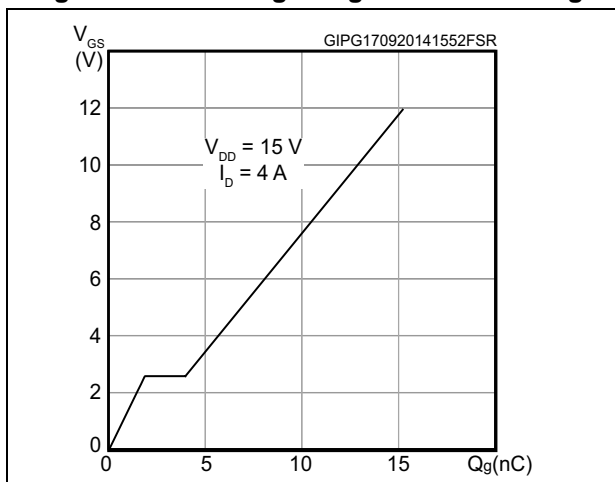

Figure 7. Static drain-source on-resistance

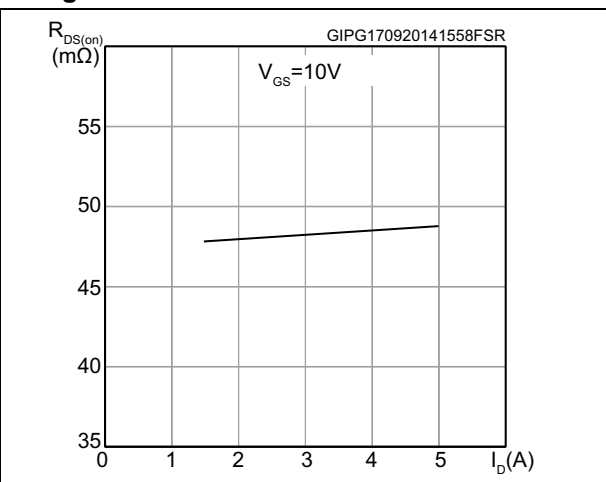

Figure 8. Normalized  $V_{(BR)DSS}$  vs temperature

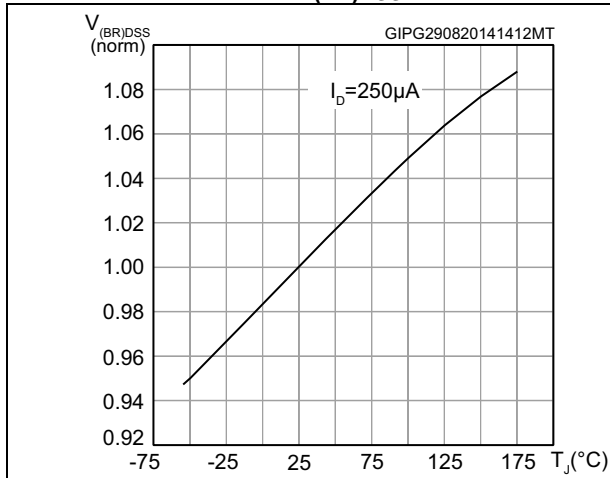

Figure 9. Capacitance variations

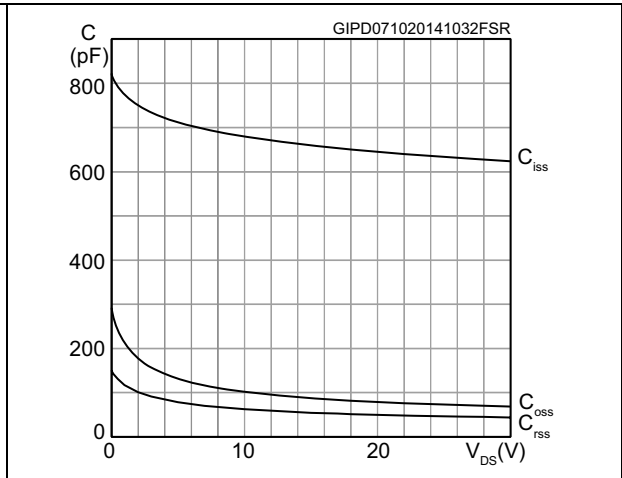

Figure 10. Normalized gate threshold voltage vs. temperature

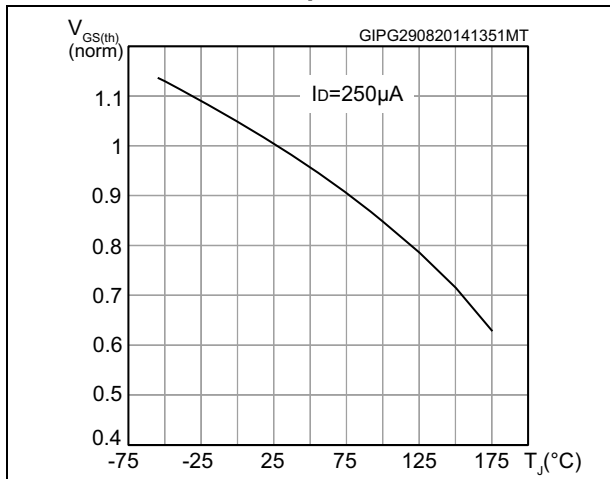

Figure 11. Normalized on-resistance vs. temperature

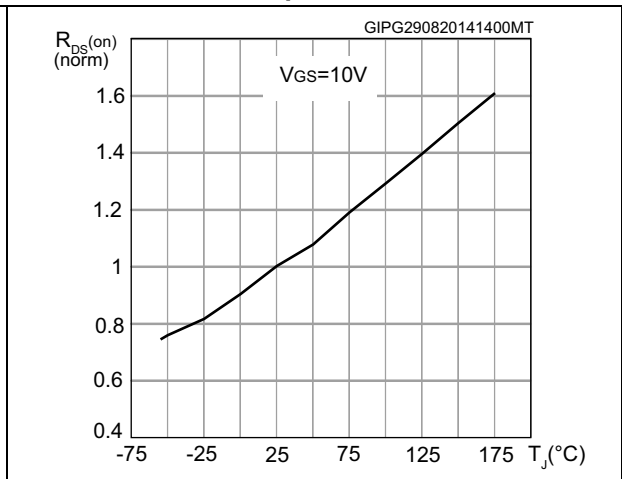
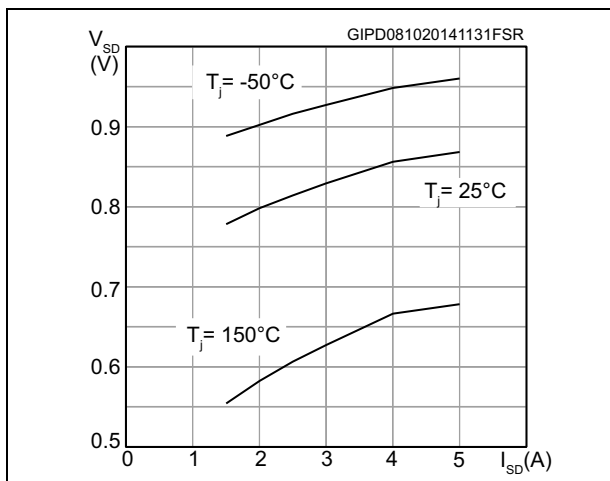

Figure 12. Source-drain diode forward characteristics



### 3 Test circuits

Figure 13. Switching times test circuit for resistive load

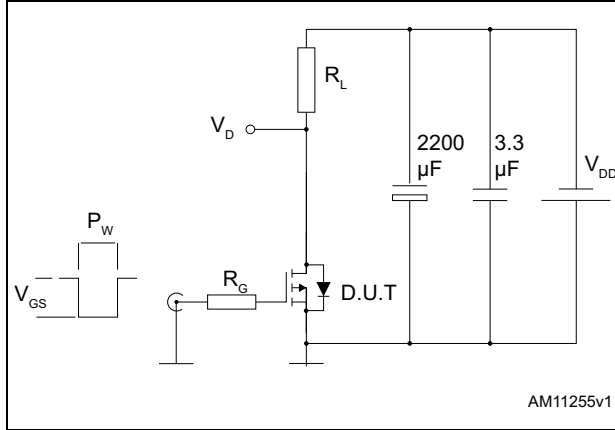

Figure 14. Gate charge test circuit

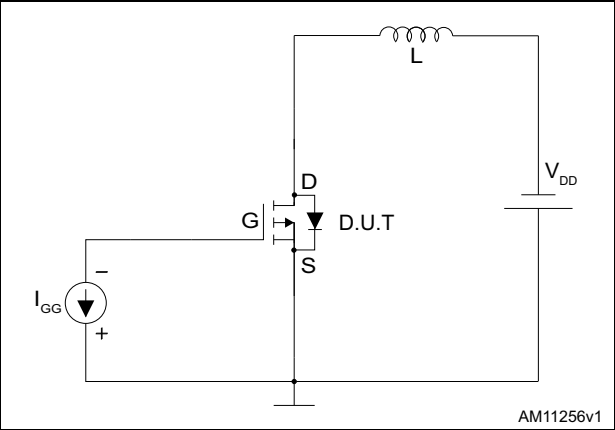
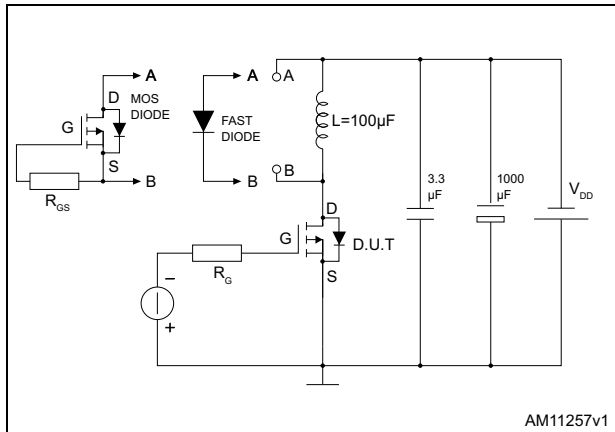

Figure 15. Test circuit for inductive load switching and diode recovery times





## 4 Package mechanical data

In order to meet environmental requirements, ST offers these devices in different grades of ECOPACK<sup>®</sup> packages, depending on their level of environmental compliance. ECOPACK<sup>®</sup> specifications, grade definitions and product status are available at: [www.st.com](http://www.st.com). ECOPACK<sup>®</sup> is an ST trademark.

**Table 8. PowerFLAT™ 2 x 2 mechanical data**

Dim.	mm.		
	Min.	Typ.	Max.
A	0.70	0.75	0.80
A1	0.00	0.02	0.05
A3		0.20	
b	0.25	0.30	0.35
D	1.90	2.00	2.10
E	1.90	2.00	2.10
D2	0.90	1.00	1.10
E2	0.80	0.90	1.00
e	0.55	0.65	0.75
K	0.15	0.25	0.35
K1	0.20	0.30	0.40
K2	0.25	0.35	0.45
L	0.20	0.25	0.30
L1	0.65	0.75	0.85

Figure 16. Drawing dimension PowerFLAT™ 2 x 2

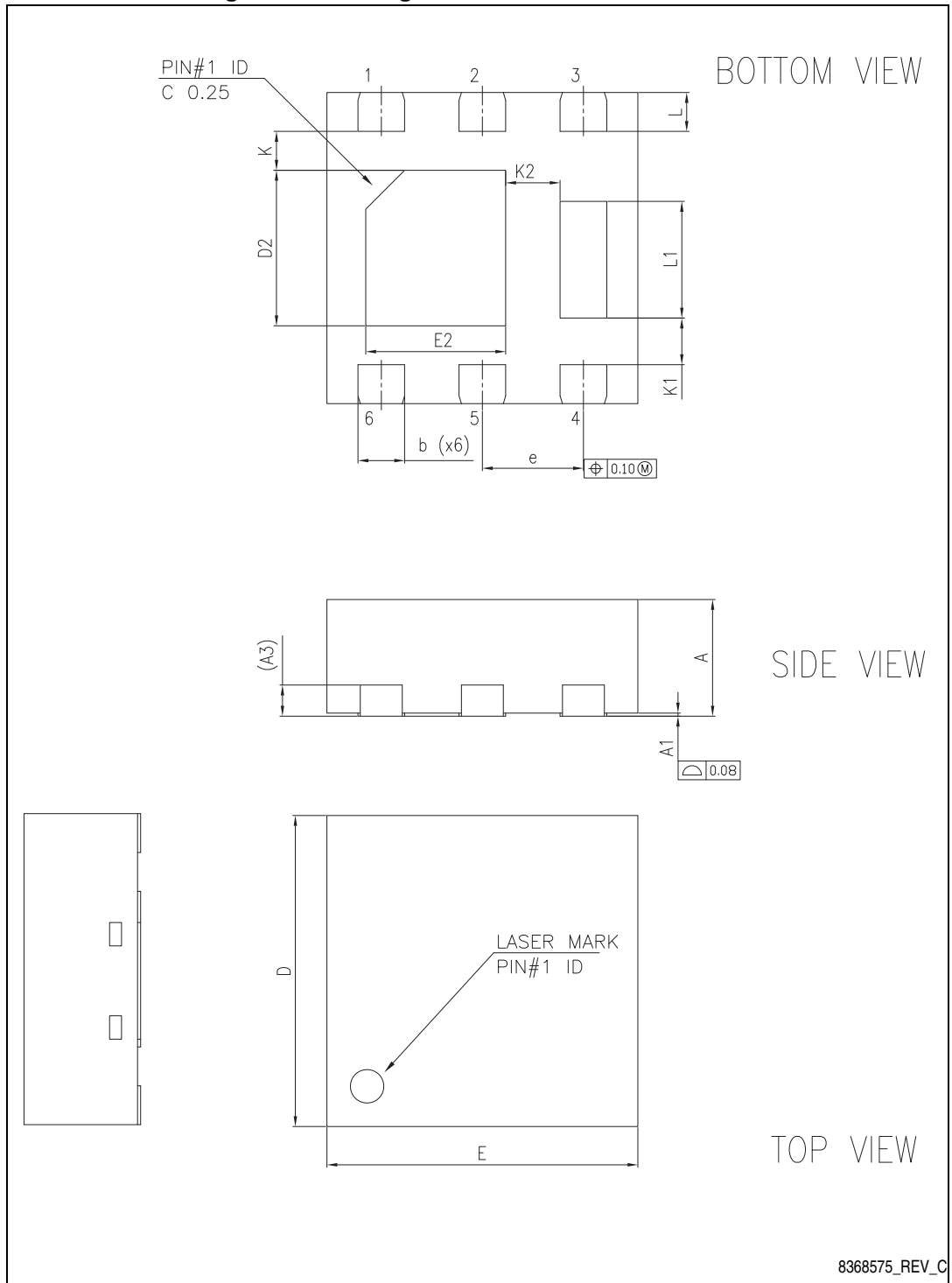

# 5 Packaging mechanical data

Figure 17. PowerFLAT™ 2 x 2 footprint (dimensions in mm)

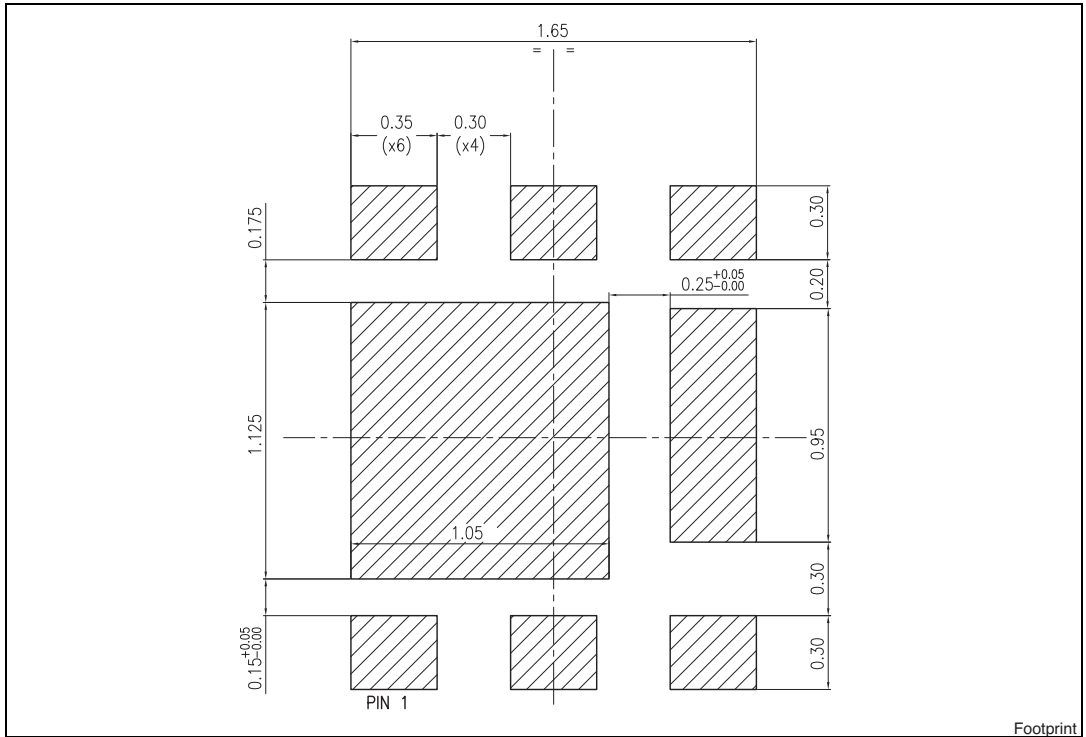

## 6 Revision history

Table 9. Document revision history

Date	Revision	Changes
09-May-2013	1	Initial release.
09-Dec-2014	2	Text edits throughout document On cover page: – changed title description – updated features and description In <a href="#">Table 4</a> , changed $R_{DS(on)}$ values In <a href="#">Table 5</a> , changed values and test conditions In <a href="#">Table 6</a> , changed values and test conditions In <a href="#">Table 7</a> , changed values and test conditions Added <a href="#">Section 2.1: Electrical characteristics (curves)</a> Updated <a href="#">Section 3: Test circuits</a> Updated <a href="#">Section 4: Package mechanical data</a>

**IMPORTANT NOTICE – PLEASE READ CAREFULLY**

STMicroelectronics NV and its subsidiaries ("ST") reserve the right to make changes, corrections, enhancements, modifications, and improvements to ST products and/or to this document at any time without notice. Purchasers should obtain the latest relevant information on ST products before placing orders. ST products are sold pursuant to ST's terms and conditions of sale in place at the time of order acknowledgement.

Purchasers are solely responsible for the choice, selection, and use of ST products and ST assumes no liability for application assistance or the design of Purchasers' products.

No license, express or implied, to any intellectual property right is granted by ST herein.

Resale of ST products with provisions different from the information set forth herein shall void any warranty granted by ST for such product.

ST and the ST logo are trademarks of ST. All other product or service names are the property of their respective owners.

Information in this document supersedes and replaces information previously supplied in any prior versions of this document.

© 2014 STMicroelectronics – All rights reserved