

## LMC6762

### Dual MicroPower Rail-To-Rail Input CMOS Comparator with Push-Pull Output

#### General Description

The LMC6762 is an ultra low power dual comparator with a maximum supply current of 10  $\mu\text{A}/\text{comparator}$ . It is designed to operate over a wide range of supply voltages, from 2.7V to 15V. The LMC6762 has guaranteed specs at 2.7V to meet the demands of 3V digital systems.

The LMC6762 has an input common-mode voltage range which exceeds both supplies. This is a significant advantage in low-voltage applications. The LMC6762 also features a push-pull output that allows direct connections to logic devices without a pull-up resistor.

A quiescent power consumption of 50  $\mu\text{W}/\text{amplifier}$  (@  $V^+ = 5\text{V}$ ) makes the LMC6762 ideal for applications in portable phones and hand-held electronics. The ultra-low supply current is also independent of power supply voltage. Guaranteed operation at 2.7V and a rail-to-rail performance makes this device ideal for battery-powered applications.

Refer to the LMC6772 datasheet for an open-drain version of this device.

#### Features

(Typical unless otherwise noted)

- Low power consumption (max):  $I_S = 10 \mu\text{A}/\text{comp}$
- Wide range of supply voltages: 2.7V to 15V
- Rail-to-rail input common mode voltage range
- Rail-to-rail output swing (Within 100 mV of the supplies, @  $V^+ = 2.7\text{V}$ , and  $I_{\text{LOAD}} = 2.5 \text{mA}$ )
- Short circuit protection: 40 mA
- Propagation delay (@  $V^+ = 5\text{V}$ , 100 mV overdrive): 4  $\mu\text{s}$

#### Applications

- Laptop computers
- Mobile phones
- Metering systems
- Hand-held electronics
- RC timers
- Alarm and monitoring circuits
- Window comparators, multivibrators

#### Connection Diagram

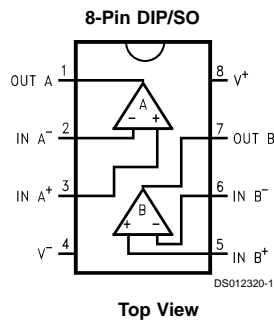

#### Ordering Information

Package	Temperature Range -40°C to +85°C	NSC Drawing	Transport Media
8-Pin Molded DIP	LMC6762AIN, LMC6762BIN	N08E	Rails
8-Pin Small Outline	LMC6762AIM, LMC6762BIM LMC6762AIMX, LMC6762BIMX	M08A M08A	Rails Tape and Reel

### Absolute Maximum Ratings (Note 1)

If Military/Aerospace specified devices are required, please contact the National Semiconductor Sales Office/Distributors for availability and specifications.

ESD Tolerance (Note 2)	2 kV
Differential Input Voltage	(V <sup>+</sup> )+0.3V to (V <sup>-</sup> )-0.3V
Voltage at Input/Output Pin	(V <sup>+</sup> )+0.3V to (V <sup>-</sup> )-0.3V
Supply Voltage (V <sup>+</sup> -V <sup>-</sup> )	16V
Current at Input Pin	±5 mA
Current at Output Pin (Notes 7, 3)	±30 mA
Current at Power Supply Pin, LMC6762	40 mA

Lead Temperature (Soldering, 10 seconds)	260°C
Storage Temperature Range	-65°C to +150°C
Junction Temperature (Note 4)	150°C

### Operating Ratings (Note 1)

Supply Voltage	2.7 ≤ V <sub>S</sub> ≤ 15V
Junction Temperature Range LMC6762AI, LMC6762BI	-40°C ≤ T <sub>J</sub> ≤ +85°C
Thermal Resistance (θ <sub>JA</sub> ) N Package, 8-Pin Molded DIP	100°C/W
M Package, 8-Pin Surface Mount	172°C/W

### 2.7V Electrical Characteristics

Unless otherwise specified, all limits guaranteed for T<sub>J</sub> = 25°C, V<sup>+</sup> = 2.7V, V<sup>-</sup> = 0V, V<sub>CM</sub> = V<sup>+</sup>/2. **Boldface** limits apply at the temperature extremes.

Symbol	Parameter	Conditions	Typ (Note 5)	LMC6762AI Limit (Note 6)	LMC6762BI Limit (Note 6)	Units
V <sub>OS</sub>	Input Offset Voltage		3	5 <b>8</b>	15 <b>18</b>	mV max
TCV <sub>OS</sub>	Input Offset Voltage Temperature Drift		2.0			μV/°C
	Input Offset Voltage Average Drift	(Note 8)	3.3			μV/Month
I <sub>B</sub>	Input Current		0.02			pA
I <sub>OS</sub>	Input Offset Current		0.01			pA
CMRR	Common Mode Rejection Ratio		75			dB
PSRR	Power Supply Rejection Ratio	±1.35V < V <sub>S</sub> < ±7.5V	80			dB
A <sub>V</sub>	Voltage Gain	(By Design)	100			dB
V <sub>CM</sub>	Input Common-Mode Voltage Range	CMRR > 55 dB	3.0	2.9 <b>2.7</b>	2.9 <b>2.7</b>	V min
			-0.3	-0.2 <b>0.0</b>	-0.2 <b>0.0</b>	V max
V <sub>OH</sub>	Output Voltage High	I <sub>LOAD</sub> = 2.5 mA	2.5	2.4 <b>2.3</b>	2.4 <b>2.3</b>	V min
V <sub>OL</sub>	Output Voltage Low	I <sub>LOAD</sub> = 2.5 mA	0.2	0.3 <b>0.4</b>	0.3 <b>0.4</b>	V max
I <sub>S</sub>	Supply Current	For Both Comparators (Output Low)	12	20 <b>25</b>	20 <b>25</b>	μA max

## 5.0V and 15.0V Electrical Characteristics

Unless otherwise specified, all limits guaranteed for  $T_J = 25^\circ\text{C}$ ,  $V^+ = 5.0\text{V}$  and  $15.0\text{V}$ ,  $V^- = 0\text{V}$ ,  $V_{\text{CM}} = V^+/2$ . **Boldface** limits apply at the temperature extremes.

Symbol	Parameter	Conditions	Typ (Note 5)	LMC6762AI Limit (Note 6)	LMC6762BI Limit (Note 6)	Units
$V_{\text{OS}}$	Input Offset Voltage		3	5 <b>8</b>	15 <b>18</b>	mV max
$\text{TCV}_{\text{OS}}$	Input Offset Voltage	$V^+ = 5\text{V}$	2.0			$\mu\text{V}/^\circ\text{C}$
	Temperature Drift	$V^+ = 15\text{V}$	4.0			
	Input Offset Voltage	$V^+ = 5\text{V}$ (Note 8)	3.3			$\mu\text{V}/\text{Month}$
	Average Drift	$V^+ = 15\text{V}$ (Note 8)	4.0			
$I_{\text{B}}$	Input Current	$V = 5\text{V}$	0.04			pA
$I_{\text{OS}}$	Input Offset Current	$V^+ = 5\text{V}$	0.02			pA
CMRR	Common Mode	$V^+ = 5\text{V}$	75			dB
	Rejection Ratio	$V^+ = 15\text{V}$	82			dB
PSRR	Power Supply Rejection Ratio	$\pm 2.5\text{V} < V_{\text{S}} < \pm 5\text{V}$	80			dB
$A_{\text{V}}$	Voltage Gain	(By Design)	100			dB
$V_{\text{CM}}$	Input Common-Mode	$V^+ = 5.0\text{V}$	5.3	5.2	5.2	V
		CMRR > 55 dB		<b>5.0</b>	<b>5.0</b>	min
	Voltage Range		-0.3	-0.2	-0.2	V
				<b>0.0</b>	<b>0.0</b>	max
		$V^+ = 15.0\text{V}$	15.3	15.2	15.2	V
		CMRR > 55 dB		<b>15.0</b>	<b>15.0</b>	min
		-0.3	-0.2	-0.2	V	
			<b>0.0</b>	<b>0.0</b>	max	
$V_{\text{OH}}$	Output Voltage High	$V^+ = 5\text{V}$	4.8	4.6	4.6	V
		$I_{\text{LOAD}} = 5\text{mA}$		<b>4.45</b>	<b>4.45</b>	min
		$V^+ = 15\text{V}$	14.8	14.6	14.6	V
		$I_{\text{LOAD}} = 5\text{mA}$		<b>14.45</b>	<b>14.45</b>	min
$V_{\text{OL}}$	Output Voltage Low	$V^+ = 5\text{V}$	0.2	0.4	0.4	V
		$I_{\text{LOAD}} = 5\text{mA}$		<b>0.55</b>	<b>0.55</b>	max
		$V^+ = 15\text{V}$	0.2	0.4	0.4	V
		$I_{\text{LOAD}} = 5\text{mA}$		<b>0.55</b>	<b>0.55</b>	max
$I_{\text{S}}$	Supply Current	For Both Comparators (Output Low)	12	20 <b>25</b>	20 <b>25</b>	$\mu\text{A}$ max
$I_{\text{SC}}$	Short Circuit Current	Sourcing	30			mA
		Sinking, $V_{\text{O}} = 12\text{V}$ (Note 7)	45			

## AC Electrical Characteristics

Unless otherwise specified, all limits guaranteed for  $T_J = 25^\circ\text{C}$ ,  $V^+ = 5\text{V}$ ,  $V^- = 0\text{V}$ ,  $V_{\text{CM}} = V_O = V^+/2$ . **Boldface** limits apply at the temperature extreme.

Symbol	Parameter	Conditions	Typ (Note 5)	LMC6762AI Limit (Note 6)	LMC6762BI Limit (Note 6)	Units
$t_{\text{RISE}}$	Rise Time	$f = 10\text{ kHz}$ , $C_L = 50\text{ pF}$ , Overdrive = 10 mV (Notes 9, 10)	0.3			$\mu\text{s}$
$t_{\text{FALL}}$	Fall Time	$f = 10\text{ kHz}$ , $C_L = 50\text{ pF}$ , Overdrive = 10 mV (Notes 9, 10)	0.3			$\mu\text{s}$
$t_{\text{PHL}}$	Propagation Delay (High to Low)	$f = 10\text{ kHz}$ , $C_L = 50\text{ pF}$ (Notes 9, 10)	Overdrive = 10 mV	10		$\mu\text{s}$
			Overdrive = 100 mV	4		$\mu\text{s}$
		$V^+ = 2.7\text{V}$ , $f = 10\text{ kHz}$ , $C_L = 50\text{ pF}$ (Notes 9, 10)	Overdrive = 10 mV	10		$\mu\text{s}$
			Overdrive = 100 mV	4		$\mu\text{s}$
$t_{\text{PLH}}$	Propagation Delay (Low to High)	$f = 10\text{ kHz}$ , $C_L = 50\text{ pF}$ (Notes 9, 10)	Overdrive = 10 mV	6		$\mu\text{s}$
			Overdrive = 100 mV	4		$\mu\text{s}$
		$V^+ = 2.7\text{V}$ , $f = 10\text{ kHz}$ , $C_L = 50\text{ pF}$ (Notes 9, 10)	Overdrive = 10 mV	7		$\mu\text{s}$
			Overdrive = 100 mV	4		$\mu\text{s}$

**Note 1:** Absolute Maximum Ratings indicate limits beyond which damage to the device may occur. Operating Ratings indicate conditions for which the device is intended to be functional, but specific performance is not guaranteed. For guaranteed specifications and the test conditions, see the electrical characteristics.

**Note 2:** Human body model, 1.5 k $\Omega$  in series with 100 pF.

**Note 3:** Applies to both single-supply and split-supply operation. Continuous short circuit operation at elevated ambient temperature can result in exceeding the maximum allowed junction temperature of 150°C. Output currents in excess of  $\pm 30\text{ mA}$  over long term may adversely affect reliability.

**Note 4:** The maximum power dissipation is a function of  $T_{\text{J(max)}}$ ,  $\theta_{\text{JA}}$ , and  $T_{\text{A}}$ . The maximum allowable power dissipation at any ambient temperature is  $P_{\text{D}} = (T_{\text{J(max)}} - T_{\text{A}})/\theta_{\text{JA}}$ . All numbers apply for packages soldered directly into a PC board.

**Note 5:** Typical Values represent the most likely parametric norm.

**Note 6:** All limits are guaranteed by testing or statistical analysis.

**Note 7:** Do not short circuit output to  $V^+$ , when  $V^+$  is greater than 12V or reliability will be adversely affected.

**Note 8:** Input Offset Voltage Average Drift is calculated by dividing the accelerated operating life drift average by the equivalent operational time. The Input Offset Voltage Average Drift represents the input offset voltage change at worst-case input conditions.

**Note 9:**  $C_L$  includes the probe and jig capacitance.

**Note 10:** The rise and fall times are measured with a 2V input step. The propagation delays are also measured with a 2V input step.

## Typical Performance Characteristics $V^+ = 5\text{V}$ , Single Supply, $T_{\text{A}} = 25^\circ\text{C}$ unless otherwise specified

**Supply Current vs Supply Voltage (Output High)**

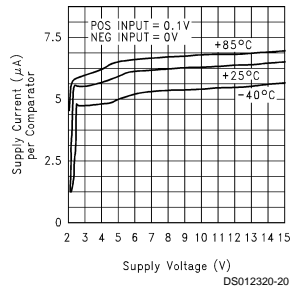

**Supply Current vs Supply Voltage (Output Low)**

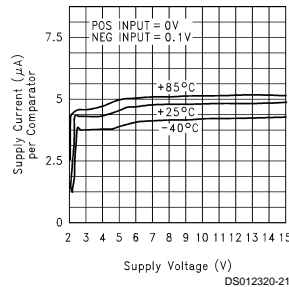

**Input Current vs Common-Mode Voltage**

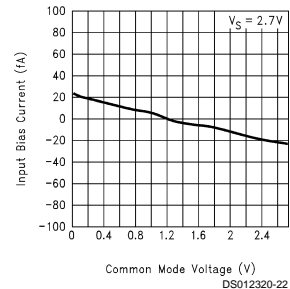

**Typical Performance Characteristics**  $V^+ = 5V$ , Single Supply,  $T_A = 25^\circ C$  unless otherwise specified (Continued)

**Input Current vs Common-Mode Voltage**

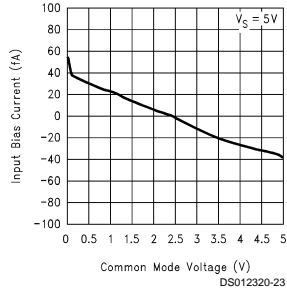

**Input Current vs Common-Mode Voltage**

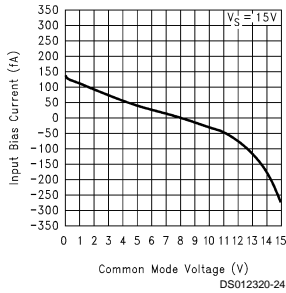

**Input Current vs Temperature**

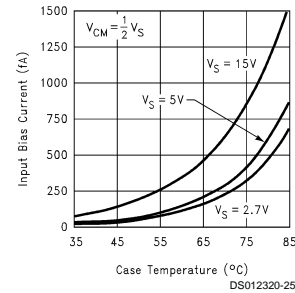

**$\Delta V_{OS}$  vs  $\Delta V_{CM}$**

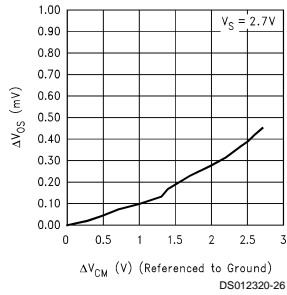

**$\Delta V_{OS}$  vs  $\Delta V_{CM}$**

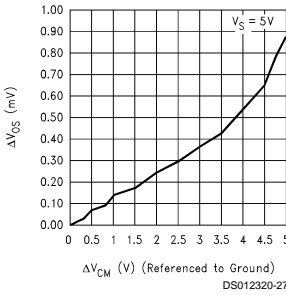

**$\Delta V_{OS}$  vs  $\Delta V_{CM}$**

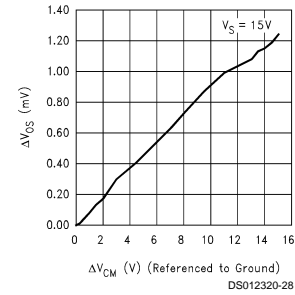

**Output Voltage vs Output Current (Sourcing)**

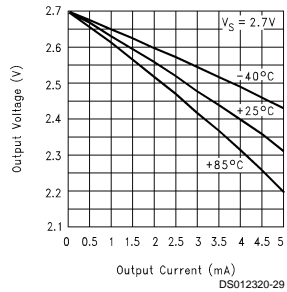

**Output Voltage vs Output Current (Sourcing)**

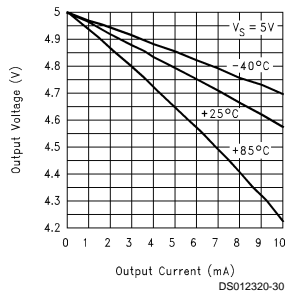

**Output Voltage vs Output Current (Sourcing)**

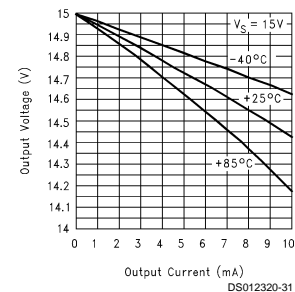

**Typical Performance Characteristics**  $V^+ = 5V$ , Single Supply,  $T_A = 25^\circ C$  unless otherwise specified (Continued)

**Output Voltage vs Output Current (Sinking)**

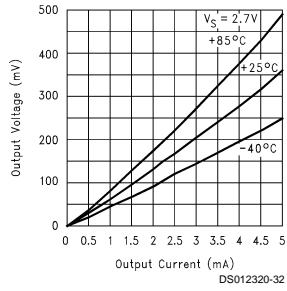

**Output Voltage vs Output Current (Sinking)**

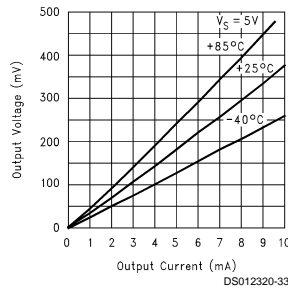

**Output Voltage vs Output Current (Sinking)**

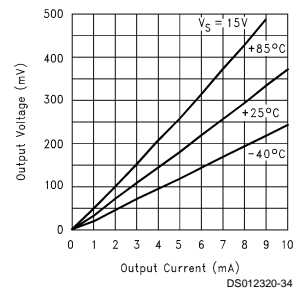

**Output Short Circuit Current vs Supply Voltage (Sourcing)**

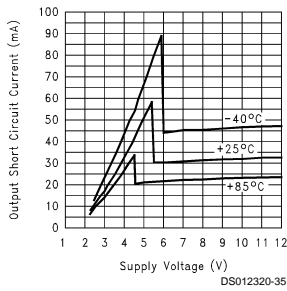

**Output Short Circuit Current vs Supply Voltage (Sinking)**

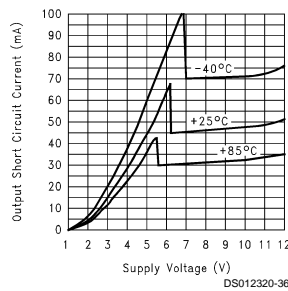

**Response Time for Overdrive ( $t_{PLH}$ )**

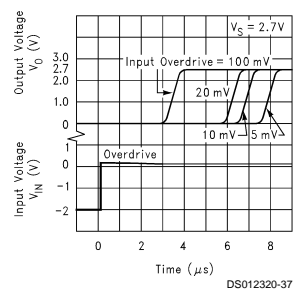

**Response Time for Overdrive ( $t_{PHL}$ )**

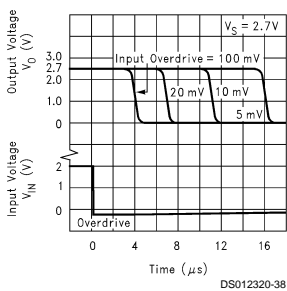

**Response Time for Overdrive ( $t_{PLH}$ )**

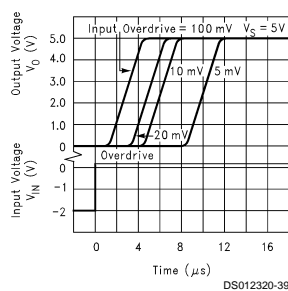

**Response Time for Overdrive ( $t_{PHL}$ )**

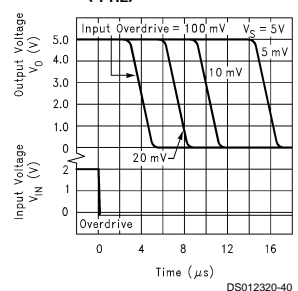

**Typical Performance Characteristics**  $V^+ = 5V$ , Single Supply,  $T_A = 25^\circ C$  unless otherwise specified (Continued)

**Response Time for Overdrive ( $t_{PLH}$ )**

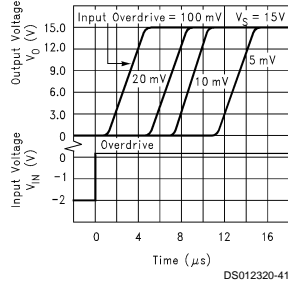

**Response Time for Overdrive ( $t_{PHL}$ )**

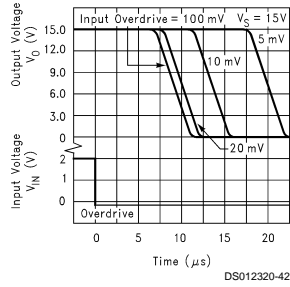

**Response Time vs Capacitive Load**

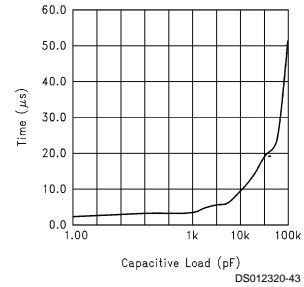

## Application Hints

### 1.0 Input Common-Mode Voltage Range

At supply voltages of 2.7V, 5V and 15V, the LMC6762 has an input common-mode voltage range which exceeds both supplies. As in the case of operational amplifiers, CMVR is defined by the  $V_{OS}$  shift of the comparator over the common-mode range of the device. A CMRR ( $\Delta V_{OS}/\Delta V_{CM}$ ) of 75 dB (typical) implies a shift of  $< 1$  mV over the entire common-mode range of the device. The absolute maximum input voltage at  $V^+ = 5V$  is 200 mV beyond either supply rail at room temperature.

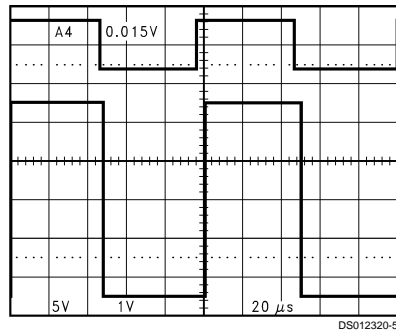

**FIGURE 1. An Input Signal Exceeds the LMC6762 Power Supply Voltages with No Output Phase Inversion**

A wide input voltage range means that the comparator can be used to sense signals close to ground and also to the power supplies. This is an extremely useful feature in power supply monitoring circuits.

An input common-mode voltage range that exceeds the supplies, 20 fA input currents (typical), and a high input impedance makes the LMC6762 ideal for sensor applications. The LMC6762 can directly interface to sensors without the use of amplifiers or bias circuits. In circuits with sensors which produce outputs in the tens to hundreds of millivolts, the LMC6762 can compare the sensor signal with an appropriately small reference voltage. This reference voltage can be close to ground or the positive supply rail.

### 2.0 Low Voltage Operation

Comparators are the common devices by which analog signals interface with digital circuits. The LMC6762 has been designed to operate at supply voltages of 2.7V without sacrificing performance to meet the demands of 3V digital systems.

At supply voltages of 2.7V, the common-mode voltage range extends 200 mV (guaranteed) below the negative supply. This feature, in addition to the comparator being able to sense signals near the positive rail, is extremely useful in low voltage applications.

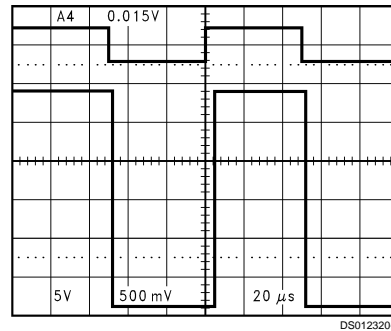
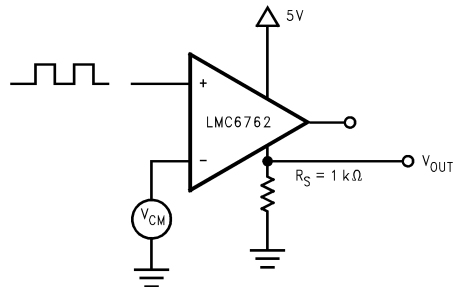

**FIGURE 2. Even at Low-Supply Voltage of 2.7V, an Input Signal which Exceeds the Supply Voltages Produces No Phase Inversion at the Output**

At  $V^+ = 2.7V$ , propagation delays are  $t_{PLH} = 4 \mu s$  and  $t_{PHL} = 4 \mu s$  with overdrives of 100 mV. Please refer to the performance curves for more extensive characterization.

### 3.0 Shoot-Through Current

The shoot-through current is defined as the current surge, above the quiescent supply current, between the positive and negative supplies of a device. The current surge occurs when the output of the device switches states. This transient switching current results in glitches in the supply voltage. Usually, glitches in the supply lines are compensated by bypass capacitors. When the switching currents are minimal, the values of the bypass capacitors can be reduced considerably.



**FIGURE 3. LMC6762 Circuit for Measurement of the Shoot-Through Current**



## Application Hints (Continued)

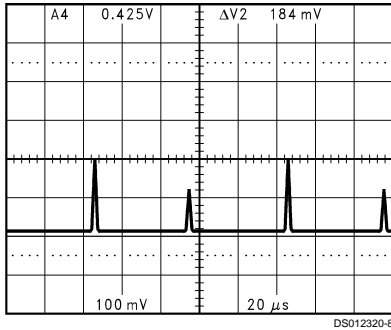
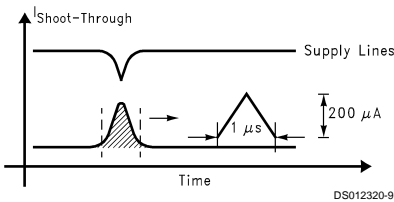

FIGURE 4. Measurement of the Shoot-Through Current

From Figure 3 and Figure 4 the shoot-through current for the LMC6762 can be approximated to be 0.2 mA (200 mV/1 kΩ). The duration of the transient is measured as 1 μs. The values needed for the local bypass capacitors can be calculated as follows:



$$\begin{aligned} \text{Area of } \Delta &= \frac{1}{2} (1 \mu\text{s} \times 200 \mu\text{A}) \\ &= 100 \text{ pC} \end{aligned}$$

If the local bypass capacitor has to provide this charge of 100 pC, the minimum value of the local capacitor to prevent local degradation of  $V_{CC}$  can be calculated. Suppose that the maximum voltage droop that the system can tolerate is 100mV,

$$\begin{aligned} \Delta Q &= C * (\Delta V) \\ \rightarrow C &= (\Delta Q / \Delta V) \\ &= 100 \text{ pC} / 100 \text{ mV} \\ &= 0.001 \mu\text{F} \end{aligned}$$

The low internal feedthrough current of the LMC6762 thus requires lower values for the local bypass capacitors. In applications where precision is not critical, this is a significant advantage, as lower values of capacitors result in savings of board space, and cost.

It is worth noting here that the delta shift of the power supply voltage due to the transient currents causes a threshold shift of the comparator. This threshold shift is reduced by the high PSRR of the comparator. However, the value of the PSRR applicable in this instance is the transient PSRR and not the DC PSRR. The transient PSRR is significantly lower than the DC PSRR.

Generally, it is a good goal to reduce the delta voltage on the power supply to a value equal to or less than the hysteresis of the comparator. For example, if the comparator has 50 mV of hysteresis, it would be reasonable to increase the value of the local bypass capacitor to 0.01 μF to reduce the voltage delta to 10 mV.

## 4.0 Output Short Circuit Current

The LMC6762 has short circuit protection of 40 mA. However, it is not designed to withstand continuous short circuits, transient voltage or current spikes, or shorts to any voltage beyond the supplies. A resistor in series with the output should reduce the effect of shorts. For outputs which send signals off PC boards additional protection devices, such as diodes to the supply rails, and varistors may be used.

## 5.0 Hysteresis

If the input signal is very noisy, the comparator output might trip several times as the input signal repeatedly passes through the threshold. This problem can be addressed by making use of hysteresis as shown below.

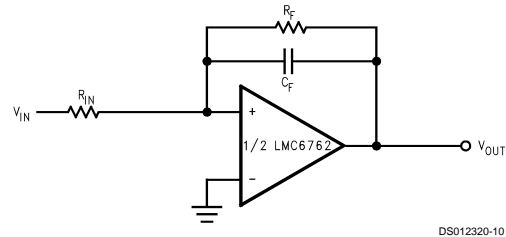

FIGURE 5. Canceling the Effect of Input Capacitance

The capacitor added across the feedback resistor increases the switching speed and provides more short term hysteresis. This can result in greater noise immunity for the circuit.

## 6.0 Spice Macromodel

A Spice Macromodel is available for the LMC6762. The model includes a simulation of:

- Input common-mode voltage range
- Quiescent and dynamic supply current
- Input overdrive characteristics

and many more characteristics as listed on the macromodel disk.

Contact the National Semiconductor Customer Response Center at 1-800-272-9959 to obtain an operational amplifier spice model library disk.

## Typical Applications

### One-Shot Multivibrator

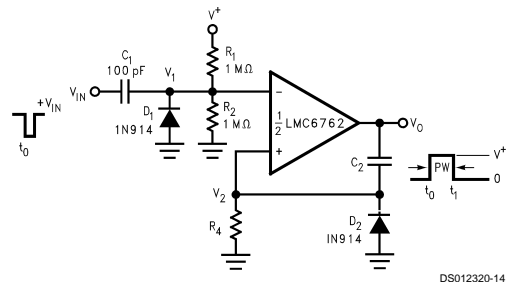

FIGURE 6. One-Shot Multivibrator

## Typical Applications (Continued)

A monostable multivibrator has one stable state in which it can remain indefinitely. It can be triggered externally to another quasi-stable state. A monostable multivibrator can thus be used to generate a pulse of desired width.

The desired pulse width is set by adjusting the values of  $C_2$  and  $R_4$ . The resistor divider of  $R_1$  and  $R_2$  can be used to determine the magnitude of the input trigger pulse. The LMC6762 will change state when  $V_1 < V_2$ . Diode  $D_2$  provides a rapid discharge path for capacitor  $C_2$  to reset at the end of the pulse. The diode also prevents the non-inverting input from being driven below ground.

### Bi-Stable Multivibrator

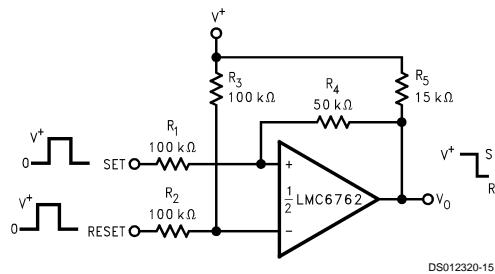

FIGURE 7. Bi-Stable Multivibrator

A bi-stable multivibrator has two stable states. The reference voltage is set up by the voltage divider of  $R_2$  and  $R_3$ . A pulse applied to the SET terminal will switch the output of the comparator high. The resistor divider of  $R_1$ ,  $R_4$ , and  $R_5$  now clamps the non-inverting input to a voltage greater than the reference voltage. A pulse applied to RESET will now toggle the output low.

### Zero Crossing Detector

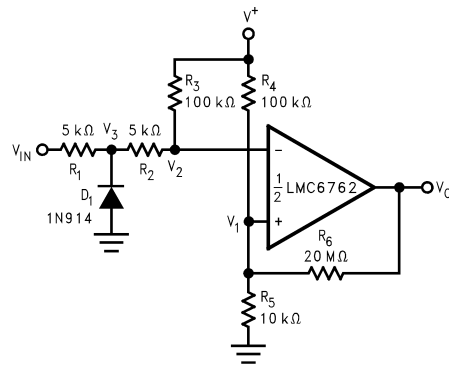

FIGURE 8. Zero Crossing Detector

A voltage divider of  $R_4$  and  $R_5$  establishes a reference voltage  $V_1$  at the non-inverting input. By making the series resistance of  $R_1$  and  $R_2$  equal to  $R_5$ , the comparator will switch when  $V_{IN} = 0$ . Diode  $D_1$  insures that  $V_3$  never drops below  $-0.7V$ . The voltage divider of  $R_2$  and  $R_3$  then prevents  $V_2$  from going below ground. A small amount of hysteresis is setup to ensure rapid output voltage transitions.

### Oscillator

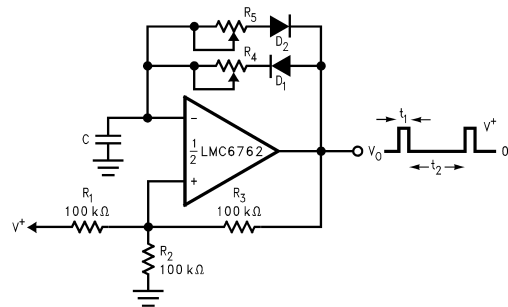
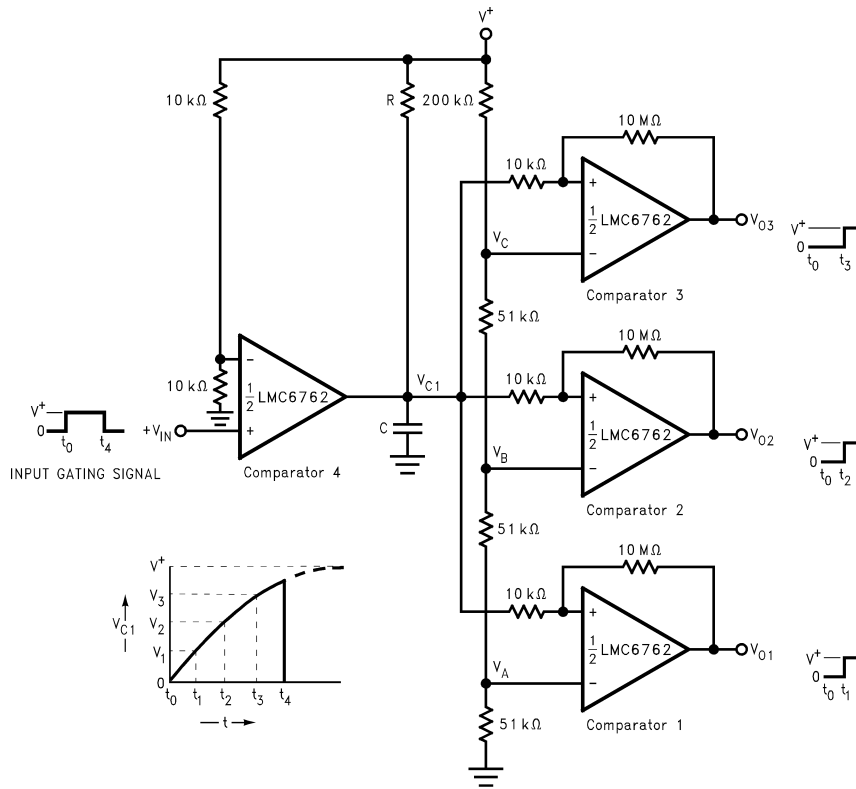

FIGURE 9. Square Wave Generator

Figure 9 shows the application of the LMC6762 in a square wave generator circuit. The total hysteresis of the loop is set by  $R_1$ ,  $R_2$  and  $R_3$ .  $R_4$  and  $R_5$  provide separate charge and discharge paths for the capacitor  $C$ . The charge path is set through  $R_4$  and  $D_1$ . So, the pulse width  $t_1$  is determined by the RC time constant of  $R_4$  and  $C$ . Similarly, the discharge path for the capacitor is set by  $R_5$  and  $D_2$ . Thus, the time  $t_2$  between the pulses can be changed by varying  $R_5$ , and the pulse width can be altered by  $R_4$ . The frequency of the output can be changed by varying both  $R_4$  and  $R_5$ .

## Typical Applications (Continued)



DS012320-18

**FIGURE 10. Time Delay Generator**

The circuit shown above provides output signals at a prescribed time interval from a time reference and automatically resets the output when the input returns to ground. Consider the case of  $V_{IN} = 0$ . The output of comparator 4 is also at ground. This implies that the outputs of comparators 1, 2, and 3 are also at ground. When an input signal is applied, the output of comparator 4 swings high and C charges exponentially through R. This is indicated above.

The output voltages of comparators 1, 2, and 3 switch to the high state when  $V_{C1}$  rises above the reference voltage  $V_A$ ,  $V_B$  and  $V_C$ . A small amount of hysteresis has been provided to insure fast switching when the RC time constant is chosen to give long delay times.

**Physical Dimensions** inches (millimeters) unless otherwise noted

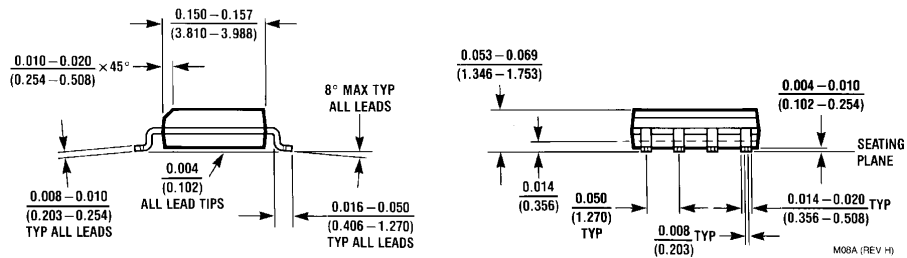
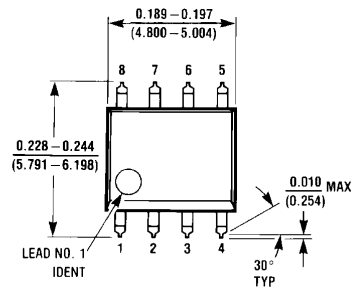

**8-Pin Small Outline Package**  
 Order Number LMC6762AIM, LMC6762BIM, LMC6762AIMX or LMC6762BIMX  
 NS Package Number M08A

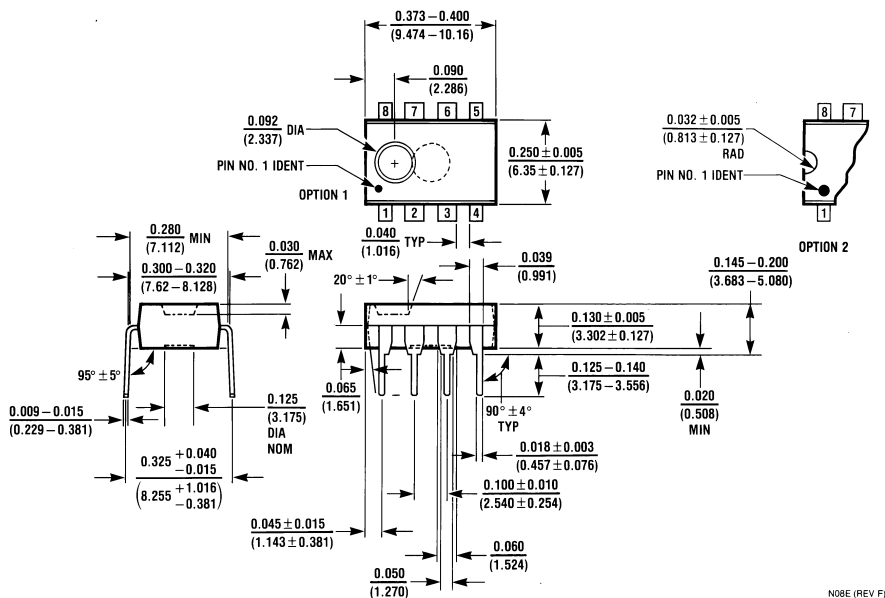

**8-Pin Molded Dual-In-Line Package**  
 Order Number LMC6762AIN or LMC6762BIN  
 NS Package Number N08E

## Notes

### LIFE SUPPORT POLICY

NATIONAL'S PRODUCTS ARE NOT AUTHORIZED FOR USE AS CRITICAL COMPONENTS IN LIFE SUPPORT DEVICES OR SYSTEMS WITHOUT THE EXPRESS WRITTEN APPROVAL OF THE PRESIDENT OF NATIONAL SEMICONDUCTOR CORPORATION. As used herein:

1. Life support devices or systems are devices or systems which, (a) are intended for surgical implant into the body, or (b) support or sustain life, and whose failure to perform when properly used in accordance with instructions for use provided in the labeling, can be reasonably expected to result in a significant injury to the user.
2. A critical component is any component of a life support device or system whose failure to perform can be reasonably expected to cause the failure of the life support device or system, or to affect its safety or effectiveness.



**National Semiconductor Corporation**  
Americas  
Tel: 1-800-272-9959  
Fax: 1-800-737-7018  
Email: support@nsc.com

[www.national.com](http://www.national.com)

**National Semiconductor Europe**  
Fax: +49 (0) 1 80-530 85 86  
Email: europe.support@nsc.com  
Deutsch Tel: +49 (0) 1 80-530 85 85  
English Tel: +49 (0) 1 80-532 78 32  
Français Tel: +49 (0) 1 80-532 93 58  
Italiano Tel: +49 (0) 1 80-534 16 80

**National Semiconductor Asia Pacific Customer Response Group**  
Tel: 65-2544466  
Fax: 65-2504466  
Email: sea.support@nsc.com

**National Semiconductor Japan Ltd.**  
Tel: 81-3-5639-7560  
Fax: 81-3-5639-7507